



# Manual

## Premier Clippers and Shears

---

2031 300th St., Washington, IA 52353 • [info@premier1supplies.com](mailto:info@premier1supplies.com)  
[Premier1Supplies.com](http://Premier1Supplies.com) • 800-282-6631

## Power Supply

Use only 110–120 AC voltage. Avoid using extension cord(s) that are either too long and/or too small (in wire gauge). Should either situation occur, the voltage actually available to the motor may be too low to drive it effectively and efficiently—resulting in low power, overheating of the motor and potential motor damage.

## Safety Issues

- The motor is double-insulated. Do not connect any wire to the E or earth pin of 3-pin plugs. Wires in the 110 leadout are color coded: White = neutral & Black = live
- Before each season, it's wise to have the clipper/shear inspected by a qualified agent.
- Use the clipper/shear only at the correct 110v AC voltage.
- Always disconnect the clipper/shear from power supply before fitting blades or dismantling the clipper/shear.

## Storing the Clipper/Shear, Blades, Combs & Cutters

- Remove the blades/combs/cutters from the clipper or shear.
- Always clean blades/combs/cutters immediately after use by using a small brush or blowing off any excess dirt or hair. Cover them with oil to reduce the risk of rust. High carbon steel clipper blades will rust overnight. Rust destroys both the edge and the polished surface of the blades.
- Store both clipper/shear and blades/combs/cutters away from solvents, chemicals and moisture. Never leave them where they can be damaged by accidental impact. We offer a blade box that has a fitted foam piece for maximum protection of blades and a comb/cutter box that comes with spun fitted polyester layers to keep combs/cutters separate and a case for the clippers.

## Sharpening Blades, Combs & Cutters

- To reproduce the quality of the cutting edge on the clipper blades that came from the factory, a lapping machine must be used. Most other methods are, in our experience, inferior to one degree or another. In addition to producing a cutting edge that won't last very long, some methods can permanently damage the blades. The most common "culprit" is using the large high speed grinding wheels that are used to sharpen cutters and combs.
- Who uses lapping machines and who does not? Obviously, Premier does and you can ship them to us. Other firms also use systems/machines that work well.

### Do's and don'ts for shipping blades to Premier (and others).

1. **Do** include payment (COD, credit card or check), name, return address, daytime phone number and specie of animal for which the blades will be used. If paying by check, please include your social security number or your order will be delayed.
2. **Do** keep clipping blade sets as pairs in the box.
3. **Don't** allow the blades/combs/cutters to rattle around in the box.
4. **Do** wrap them in paper or wool felt to protect them.
5. **Do** clean in soapy water and cover them lightly with oil or WD40™ before shipping. Premier adds a surcharge for cleaning blades/combs/cutters that are too dirty.
6. **Do** ship dry blades. Blades must be thoroughly dry (no water) before shipping.
7. **Don't** use so much grease or oil that it soaks up the box.

Send blades to:  
PREMIER SUPPLIES  
2031 300th Street  
Washington, IA 52353

**WARNING!** Clipper blades/cutters/combs that have been sharpened by inferior methods or inexperienced people may be damaged to such an extent that they can never be restored to a satisfactory cutting capability. The same is true of blades that have become too heavily pitted by rust.

## The Premier 4000c Clipper

- Slick shear lambs
- Prepare sale cattle
- Clip show cattle, goats and pigs
- Professional horse clipping



Uniquely fast, powerful and compact—a delight to use for those in a hurry. Plows straight through dense, thick fiber. Large, high speed permanent magnet (rare earth magnets) motor enables it to deliver more torque to the blades than any other brand even though it's much smaller to grip, lighter in weight, and shorter in length than all other large clippers.

Drives a shear head with cutter and combs with equal power.

### Why did we discontinue the Premier 3000?

We noticed that most users who bought it wanted, in time, to upgrade to the faster, more powerful 4000. So it made sense to sell only the 4000.

### Are all Premier 4000c clippers the same?

No. In 2002 we made the following changes:

1. The pins in the head that hold the lower blade are alloy metal instead of plastic (We eliminated pin wear and loss issues in exchange for a little more vibration.)
2. The on-off switch is smaller-less prone to being turned off inadvertently.
3. Motor speed has increased by approximately 10%
4. Motor is made in the USA instead of Europe.
5. Air is forced out forward through the head-keeps the head cooler.

### New Clipper Head—Improved in 2009!

1. New look!
2. Internal roller bearings instead of bushings (less heat, less wear and greater longevity)
3. Sleek, low profile head design
4. Improved design of stainless steel inserts to reduce risk of these falling out.

## Setting Tension for Clipping Head

1. Remove knob, bolt and spring.
2. Fit the blades on to the clipper head. The top blade will fit into the groove of the clipper head. The bottom blade should be placed over the comb pegs with the Premier logo visible. Screw the tension nut down hand-tight.
3. Turn the tension nut back two turns.
4. Oil the blades. Apply a few drops of oil at least every 3 min. to prolong blade sharpness and reduce friction and heating. Also apply a few drops to the hole labeled "oil" every 10–15 minutes. This oils the round bushing that drives the top blade back and forth.



**WARNING!** If the clipper stops cutting, do not try to force it to cut by turning the nut down and increasing the tension. That will cause overheating, extra blade wear and may damage the motor—and it won't cut any better. Instead, remove the blades, clean the cutting surfaces and replace them at the correct tension. If they still do not cut, have the blades resharpened.

# Choosing the Right Clipping Blade Set for each situation

## Premier Top Blade

It is the upper and moving portion of Premier's blade sets. Also available as a replacement. The top blade is included with every Premier Super Surgical, Surgical, Fine, Medium and Coarse Blade Set.

## Premier Super Surgical Blade Set

35 teeth. 0.02 normal cutting depth. Trims the closest of any blade available. It can give thin skinned animals the appearance of razor burn if not used by an experienced clipper. This blade can only be sharpened 1 to 3 times in its lifetime.

- For slick shearing lambs
- For surgical procedures

## Premier Surgical Blade Set

35 teeth. 0.04 normal cutting depth. Surgical blades shave the fiber right down to the skin. Very smooth result.

- For slick shearing lambs
- For surgical procedures

## Premier Fine Blade Set

35 teeth. 0.06 normal cutting depth.

- For slick shearing sheep
- For clipping heads and bellies of cattle
- For body clipping performance horses

## Premier Medium Blade Set

35 teeth. 0.08 cutting depth (twice a surgical blade set).

- For body clipping horses
- For slick shearing pink-shinned sheep

## Premier Coarse Blade Set

18 teeth. 0.12 in. cutting depth. Half as many teeth as Fine/Medium's. Leaves more fiber, but a less even finish.

- For clipping llamas/alpacas
- For body clipping dirty, dense, matted hair on dogs and horses

## Premier Xtra Cover Blade Set

24 lower teeth; 22 upper teeth. 0.25 in. cutting depth. Leaves 300% more fiber depth than a "Premier Fine". Make sure to follow your local or state rules for appropriate length of hair to be left on pigs.

- For clipping show pigs and goats
- Leaves smooth, even high fiber finish on cattle and sheep for production sales

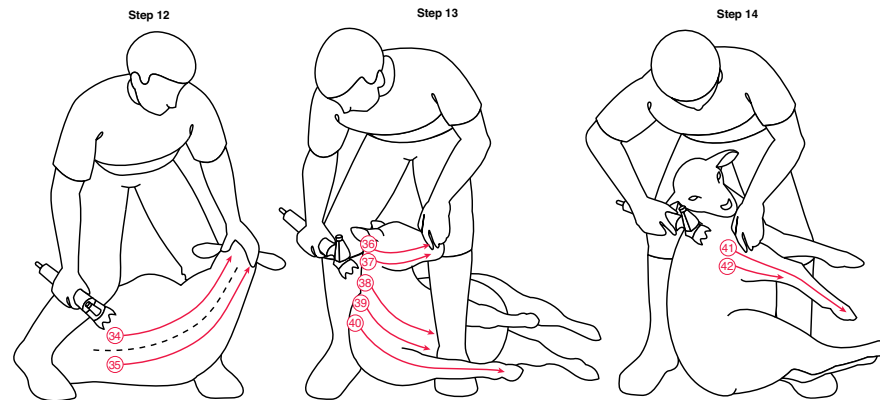

- Blows 34 and 35 must be parallel to the backbone. Lean back on your left leg. On reaching backbone make sure sheep tail is behind your right foot. Your left leg is under sheep's shoulder, with your left foot across sheep to give leverage. Apply downward pressure to sheep's head with your left hand to "roll" sheep up. Shear two strokes over backbone to save time on "last side." Avoid standing on or tearing fleece when swinging right leg out to shear "last side."
- Control the head with your knees using your fingers under the jaw to bring the sheep up. After clearing wool from ear and face, shear straight down to point of shoulder, using left hand to straighten wrinkles. Allow sheep's right foreleg to come forward after the second blow.
- Keep the shoulder well bowed out with your knees.

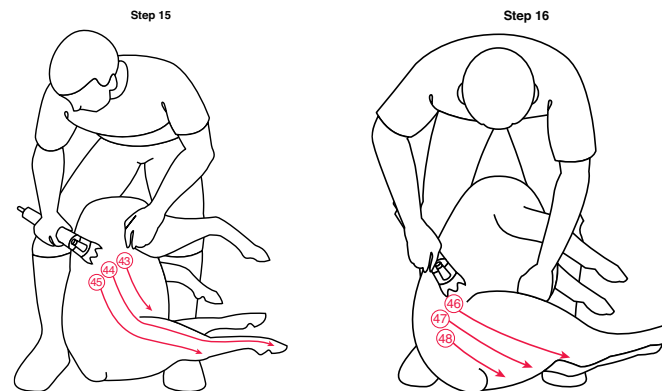

- These blows are angled to cross the wrinkles. Straighten your legs. Push down on point of shoulder with palm of hand. At the same time pull skin up with finger to clean tags under front leg. On final stroke turn handpiece under front leg and shear to toe.
- The final step is to close your fingers on the loose flank skin and roll your fist on to the firm part of the leg. Using a full comb, make remaining strokes at same angle to toe. With sheep in position, hold skin of right flank in left and apply pressure to stifle joint. Caution: slide comb at angle around ham string to avoid accidental cutting. Hold sheep's head between left arm and right leg moving left foot back so sheep settles down on its side and moving right foot forward to allow more reach for last strokes. Left foot keeps sheep's shoulder and feet off floor.

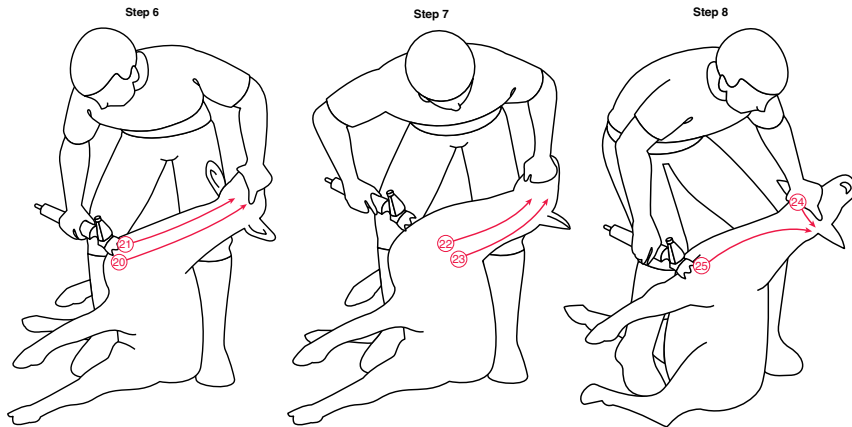

6. Stretch the head back with your left hand to allow blow 21 to finish under the jaw. Left foot close to sheep's hip, right foot in crotch between legs.

7. Turn sheep's head so the nose is up and the right side against leg. Hold body firmly between knees. Left hand is shifted toward nose as strokes are completed along jaw.

**NOTE:** The forward position of the left foot.

8. Blow 24 should clear to the far ear. On very woolly sheep, blow 23 continues over near the eye and nose. Roll the sheep's head around your knee.

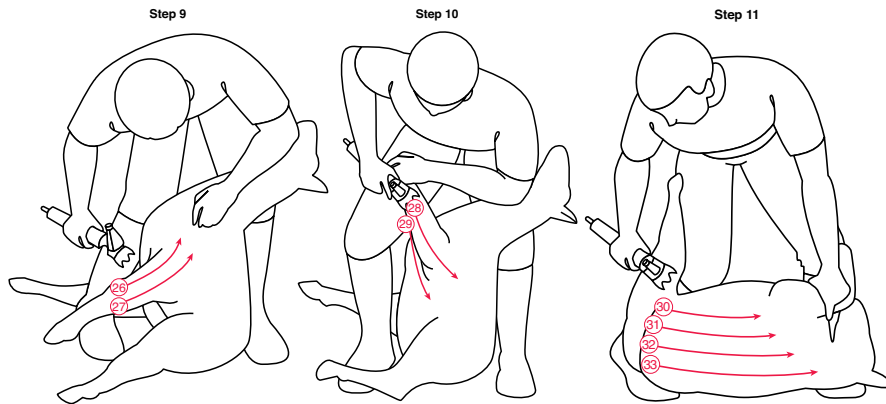

9. Press your right knee into the sheep's brisket to gain greater control. Tuck your right foot into the tail. Use left hand to stretch skin on shoulder, start stroke at knee shearing upward to clean tags on front of shoulder.

10. Blow 29 clears the inside of the leg.

11. Bend low over the sheep and keep your right shoulder well down. Lay sheep on its back, keep right foot between sheep's hind legs, left foot under right shoulder as shown, force left foreleg toward sheep's head to stretch skin on side.

## Preparing the Animal for Clipping

- **Remove the dirt from the hair first.** If this is not done, expect accelerated blade wear and a reduction in animals clipped between blade sharpenings in exact proportion to the amount of dirt present. The benefits of dirt removal prior to clipping cannot be over-emphasized. Example: Those who wash their lambs prior to clipping often clip 20–30 club lambs between sharpenings (if the blades have been sharpened properly on a lapping machine). Those who don't and have lambs with sand and soil in the wool often clip less than two lambs between sharpenings.
- **Washing the animal with soap and water removes the most dirt.** If this is not practical, use a high power vacuum or blower to remove as much dirt as possible from the hair or wool.
- **Restrain the animal.** Few animals like the sound of a clipper or the feel of vibration on their skin. When they react to either without warning, accidents can and will happen. Therefore, for the sake of you, your animal and your clipper, restrain the animal properly prior to clipping.

## Clipping Machine Lubrication

**Oil Points** (see diagram at right)

1. Oil the Round Drive
2. Oil tips of the upper and lower blades with oil—frequently.
3. Oil Guide Blocks /Stainless Inserts



- **Purpose?** To reduce blade wear, blade heat build-up and the load on the clipper motor.
- **How often?** Most do not lubricate frequently enough—and use too much oil when they do so. Apply three drops of oil every 3 minutes to the tips of the teeth. If the hair, wool or fiber is very dry (e.g. alpaca and llama fibers), the lubrication must be more frequent. If the hair is wet or contains natural oils (e.g. unwashed sheep with lanolin in their wool) the lubrication can be less frequent.
- **Where should the oil be placed?** On to the top of the blades at the front of the head (2 above)—very important to oil frequently. Every 10 minutes (every third blade lubrication), oil the round drive (1 above). Also on outer tips of the two guide blocks of the upper blade (3 above).
- **Do you need to remove blades to lubricate them?** Not unless they stop cutting.
- **What type of oil should be used?** We supply #10 White Clipping Oil because it is thick enough to lubricate, thin enough not to collect dirt and hair fibers and clear—thus reducing the risk of oil stains on the animal. If you wish to use another oil, be careful not to use oil that is too thick.
- **What about blade washes?** They are rarely needed. It is better to simply oil frequently and use a brush to remove any loose hair that may accumulate on the top of the blades.
- **WARNING:** If you use blade wash or dip the blades in an oil bath, be very careful not to tip the clipper upwards until it has run for 5 seconds. Otherwise, lubricant may run backwards through the lubricated head and eventually foul the gears & motor.
- **What about spray-on blade coolants?** They accelerate evaporation from the blade surfaces and thus do cool the blades more rapidly. However, all blade coolants are also excellent solvents—that remove the oil from the blades at the same time. So, if you use a coolant, immediately re-oil after the solvent/coolant has evaporated and before you continue clipping. You also need to check the tension of the blades. If they are becoming hot, the tension is probably too tight and/or the blades need more frequent lubrication with the correct oil.

# Important Warnings



## Ventilated motors:

Do not attempt to connect this forward ventilated motor to any Premier shear head or clipper head acquired by yourself or your dealer before June 20, 2003.

**If you do the motor will overheat & destroy the internal windings.**

Why? The air from this motor is driven forward and out through the heads. This is a new feature that results in cooler operating temperatures (up to 20 degrees less) of heads, blades, combs and cutters. However, for this to occur the shear head or clipper head is designed to enable the air to exit through the head. Older clipper heads can easily be changed to allow this by knocking out the 2 black plastic kidney-shaped plugs on either side of the drive shaft.

**Shear heads supplied before June 20, 2003 will need to be sent back to Premier for retrofitting before they can be fitted to this motor.**

## Clipping Machine Warning:

Unlike some other clipper motors, this motor will neither slow down nor sound different when oil is needed. But failure to oil will quickly cause damage to the blades and drive head. So you must apply oil by time instead of sound. Apply a small amount of oil every 3 minutes to the tips of the teeth and each side of the blade by dipping them into a dish of oil or pouring oil directly onto the teeth with a small oil container. And every 10 minutes drip oil into the small hole behind the tension assembly.

**Excessive wear can occur if not oiled properly!**

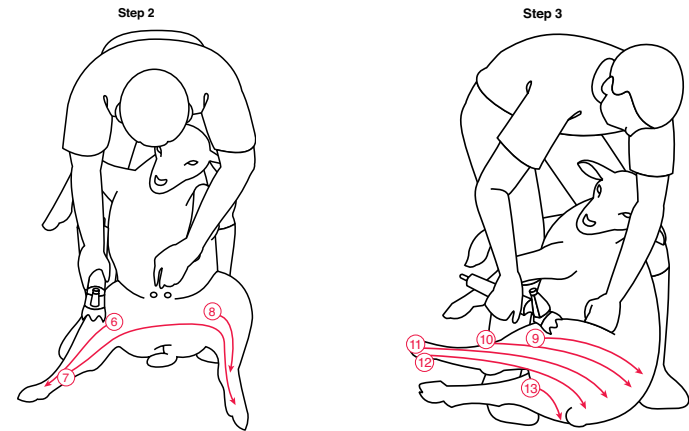

- Blow 7 may have to be repeated to ensure a clean crutch. Be careful to avoid cutting teats which should be covered with the fingers.
- Blow 10, 11 and 12 must finish in line on the near side of the backbone. Your right knee should be in front of the brisket and your foot should move back. First stroke out inside of right back leg. Second stroke starts on the toe and goes up and back around the udder.

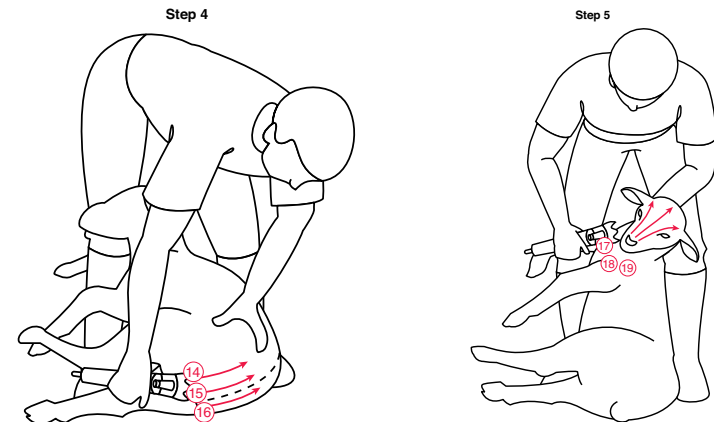

- Using left hand apply pressure to the left stifle joint to make sheep hold leg straight out. Note right front leg of sheep has dropped between shearer's legs. Also shearer should move his right leg back a few inches to help turn sheep. Drop wrist to position the comb to enter wool on top of tail and shear forward along backbone cleaning all wool from tail.

**NOTE:** Backbone shown as—  
On all sheep one full comb must be shorn over the backbone as in blow 15.  
An extra blow (16) will be needed for long wools.

- Keep comb points on the skin until they reach the base of the ears. Now move your left foot through first and bring your right foot between the sheep's hind legs.

# Shearing Instructions

## Six key points of good shearing

- 1. Control of the sheep**—get right down over the sheep and “become part of it.”
- 2. Positive hand**—know exactly where the handpiece has to go; don’t poke, be positive with all blows.
- 3. Good wrist**—must be flexible and supple to ensure comb points stay on the skin.
- 4. Return action**—must be fast, close to the sheep and taken no further back than the start of the next blow; wasted inches are wasted effort.
- 5. Left hand**—use it confidently to prepare the way for the handpiece.
- 6. Rhythm and timing**—develop a rhythm so the shearing of each section runs smoothly into the next.

## Shearing Pattern—key points to eliminate second cuts

- Keep bottom tooth on the skin
- Start and finish each blow on the skin
- Shear in position
- Shear to a pattern

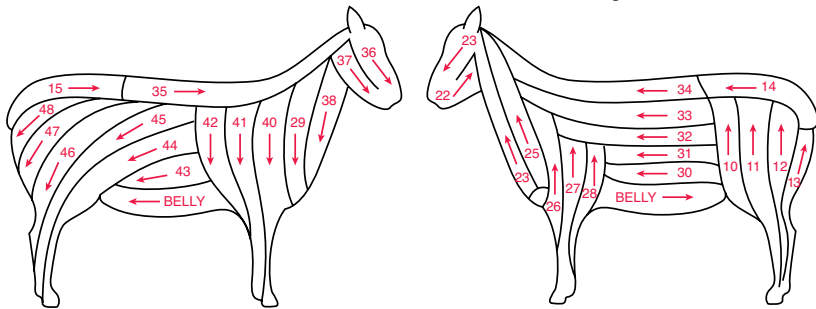

Step 1a - The Spear Belly



Step 1b - The Bowen Belly

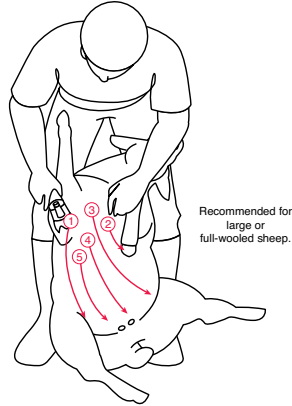

1. Support sheep firmly between your knees. Rest sheep’s foreleg on your left side to tighten skin on belly. Make first stroke of the handpiece straight down on right side of brisket to the open flank area. Make the second stroke on the left side of brisket down under left front leg. Follow strokes three and four to the left flank area.

**NOTE:** That sheep’s left front leg is held by shearer’s left wrist, leaving his hand free to tighten skin on the belly area.

# Premier 4000c Clipper Head Parts

Item No.	Part No.	Description
01	82800401	1 - Tension nut
02	82800402	1 - Tension spring
03	82800405	1 - Upper blade guide
04	82800406	1 - Tension bolt
05	82800407	1 - Blade positioner
06	89600610	2 - Head screws and 2 washers (sold as a set)
07	82800409	1 - Crank spindle cover kit (includes crank spindle, tension lock spring & excenter head)
08	82800411	1 - Small bearing
09	82800412	1 - Large bearing
10	82800414	1 - Crank spindle with fibergear

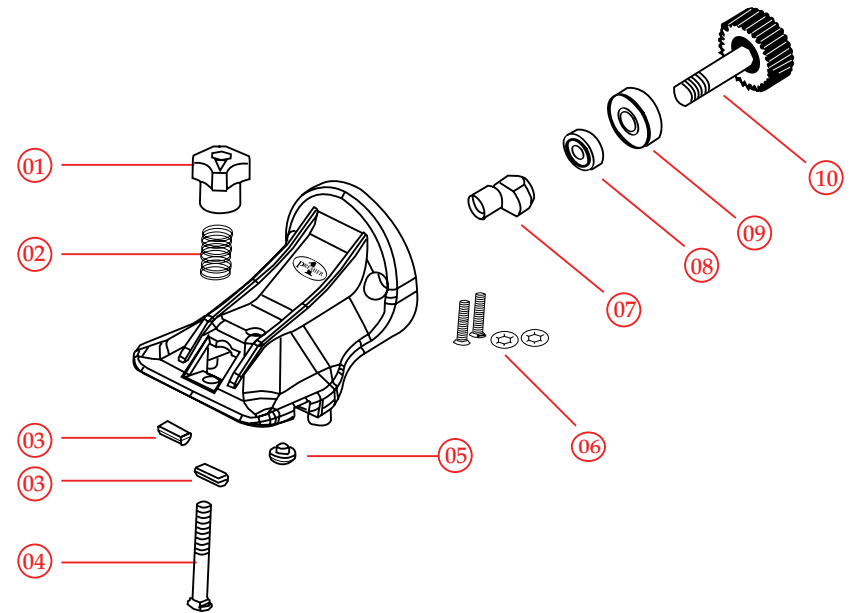

Premier recommends returning units back to us for internal repairs.

# The Premier 4000s Shear

- Shear sheep, llamas & alpacas
- Prepare cattle for sale
- Block show cattle and sheep



High cutter speed under load, compact body size and a powerful (high torque) motor are specifically combined for high speed wool and fiber removal. This machine often “wows” those used to other motor-in-the-handpiece shearing machines.

This machine is designed for high speed whole—flock shearing. When high speed wool removal is important and practical, maximum speed and power is preferred.

## Interchangeable Shear Head

### 2009 Improvements

- Internal roller bearings instead of bushings (less heat, less wear and greater longevity)
- Sleek, low profile head design.
- Suspended fork system (reduces risk of stripping the gear drive or breaking comb teeth)
- No cutter retainer or retaining spring (both caused hassles and broke too readily).
- Improved tensioning concept (spring clip is more effective at retaining than cupped washers)
- No more black plastic sides (these were prone to falling off and frustrating users)
- Tension column far superior in design, less small/individual parts to wear out.

### Changing your shear head

On the old style models, the 4000c clipping head takes different and longer screws than the 4000s shear head. When changing heads, you must change screws also. Screws included with purchase of each head. If you have the old style—the holes will be non-counterboard (or sunk in). New ones are already counterboard or sunk into the holes and screws are the same in both head



**Fitting Comb & Cutter to Unit** (see next page)

# 4000s Shearing Head Parts

Item No.	Part No.	Description
01	82900401	1 - Tension nut
02	82900402	1 - Sliding sleeve
03	82900403	1 - Tension lock spring
04	82900404	1 - Lid bushing
05	82900405	1 - Shearing head (without accessories)
06	82900406	1 - Plastic head cover
07	82900407	1 - Head cover screw
08	82900408	1 - Fork guide bracket
09	82900409	1 - Fork plate
10	82900410	1 - Fork finger (right)
11	82900411	1 - Fork finger (left)
12	82900412	1 - Comb screw
13	82900413	1 - Fulcrum lock nut
14	82900414	1 - Countersunk head screw
15	82900415	1 - Toothed washer
16	82900416	1 - Fulcrum post screw
17	82900417	1 - Tension spring plate
18	82900418	1 - Crank roller
19	82900419	1 - Crank spindle shaft
20	82900420	1 - Bearing
21	82900422	1 - Spindle hub with fibergear
22	89600610	2 - Head screws and 2 washers (sold as a set)

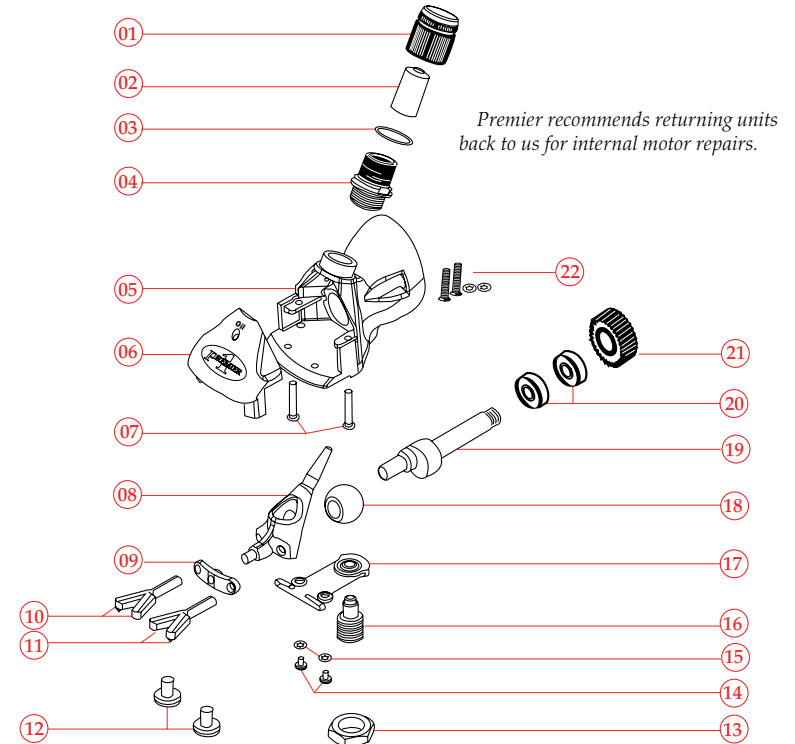

# Important Warnings



## Ventilated Motors:

Do not attempt to connect this motor to any Premier shear head or clipper head acquired by yourself or your dealer before June 20, 2003.

**If you do the motor will overheat and destroy the internal windings.**

Why? The air from this motor is driven forward and out through the heads. This is a new feature that results in cooler operating temperatures (up to 20 degrees less) of heads, blades, combs and cutters. However, for this to occur the shear head or clipper head is designed to enable the air to exit through the head. Older clipper heads can easily be changed to allow this by knocking out the 2 black plastic kidney-shaped plugs on either side of the drive shaft.

**Shear heads supplied before June 20, 2003 will need to be sent back to Premier for retrofitting before they can be fitted to this motor.**

## Shear Machine Warning:

Do not switch this machine on unless the 4 point cutter is properly in place and tensioned against the comb. As a guide, screw the tension knob down against the cutter until resistance is felt, making sure that the fork fingers are tight against the cutter. Then screw it another 1/2 turn further before switching the machine on.

# Tips to fit comb & cutter to shear head

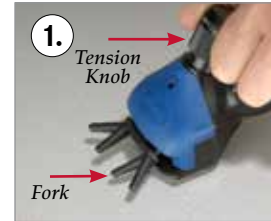

## Getting started

Loosen the tension knob (shown above) so the two forks on the shear head can move freely.

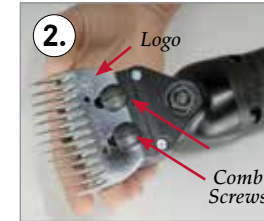

## Comb attachment

Turn machine over. Loosen the 2 screws. Slide on the comb. Premier logo on the comb in this position.



Tighten both screws just enough to hold the comb in place. (You will securely tighten the screws later.)

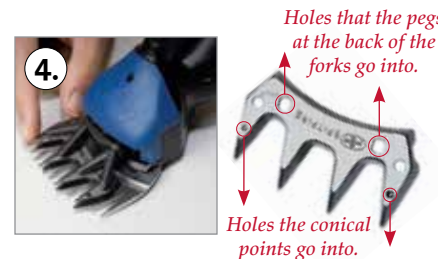

## Cutter attachment

Turn machine back over. Insert the cutter under the forks. Make sure that the 2 conical points of the fork's outer fingers are embedded into the holes on the outer 2 teeth of the cutter (above). Then screw the tension knob down against the cutter until light resistance is felt.

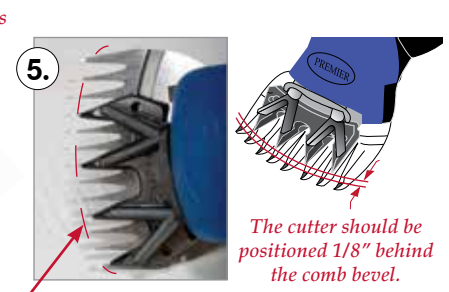

## Setting correct lead

Notice the cutter's position in relationship to the comb. The cutter should be positioned 1/8" behind the comb bevel. If not, turn the machine over and loosen the comb screws (as explained in step 1) slightly. Adjust comb as needed—by sliding the comb forwards or backwards.



## Setting correct cutter "throw"

When checking the cutter lead, also make sure that the outside cutter tooth covers no more than 1/2 of the outside tooth of the comb. Adjust the comb left or right to achieve this while also maintaining the correct lead setting of 1/8".



## Securing the comb position

Tighten the comb screws very firmly with a proper screwdriver. This cannot be done with an ordinary screwdriver. Once the comb screws are tight the cutters can be replaced by releasing the tension knob.



## Setting correct final tension

Turn the machine back over and tighten the tension knob down until notable resistance is felt. Then screw it a 1/2 turn more. Apply shearing oil to the comb and cutter. Start the motor. Tweak tension according to blade heat/cutting ability.



# Choosing the Right Cutter and Comb for each situation

## Spitfire Cutter

Standard 4 point cutter. Works on all 13, 17, 20, 22 and 23 tooth combs. Fits all 4 point 3 in. handpieces. Available in thick (4.0 mm) and thin (3.5 mm) versions. Thin pushes through wool with less resistance.

- For use with most combs to shear sheep, goats, llamas and show cattle

## Storm Cutter

Specifically made for use with 9 tooth combs like our Apache. Tooth shape enables cutter to run evenly across the comb.

## Camelid Comb

13 teeth (every other one elevated). 3.65 mm thick, 77 mm wide. Leaves a cover of 6–10 mm of hair/wool. Twin beveled.

- Specialized comb for shearing llamas, alpacas, vicunas, guanacos & camels

## Spirit Comb

13 teeth. 3.2 mm thick, 77 mm wide. General purpose comb similar in function to Heiniger's Ovina, Sunbeam's Pacer and Oster's P1082.

- For less experienced shearers
- For tagging and trimming sheep

## Phantom R Comb

20 teeth. 3.4 mm thick, 77 mm wide. Has rounded tooth tips & shearer's bevel to reduce nicks and cuts. Similar to Oster 7112 Goat comb, Sullivan's Beveled comb.

- For precision shaping of show animals
- For shearing llamas/alpacas.
- For shearing goats & coarse woolled sheep

## Phantom S Comb

20 teeth. 3.4 mm thick, 92 mm wide. Identical to Phantom R but with sharp tooth tips and no shearer's bevel. Similar in function to Oster 20 TBC, Sullivan's Blocking Comb. Do not use for shearing against the skin.

- For precision shaping of show cattle and show sheep

## Apache Comb

9 teeth. 92 mm, medium bevels. 3.6 mm thick. Enable faster shearing with less effort. Many professionals prefer them. Leaves extra wool for protection from cold or sun. Similar in function to Super 9 or Mach 9.

- For shearing range ewes, feeder lambs and farm flocks in winter

## Blackhawk 92 Comb

13 teeth with only one side flared. Medium to long bevels, 92 mm wide, 3.3 mm thick.

- For shearing farm and range flocks
- For blocking show sheep

## Blackhawk 94 Comb

13 teeth with both sides flared. Long bevels, 94 mm wide, 3.1 mm thick.

- For blocking show sheep
- For shearing fine woolled sheep
- For shearing medium woolled sheep with sticky/tight fleeces

## Heiniger's Mohair Comb

17 teeth. 3.5 mm thick, 90 mm wide. Extra teeth reduces risk of nicks and leaves smoother results. Perfectly fits the needs of shearing Angora goats.

- Preferred by some for shearing Angora goats, llamas and alpacas

# Shear Machine Lubrication

## Oil Points (see diagram at right)

1. Oil tips of the upper comb and lower cutter with plenty of oil—frequently.
2. Oil Round Drive. Apply oil into hole labeled oil on the blue plastic cover.

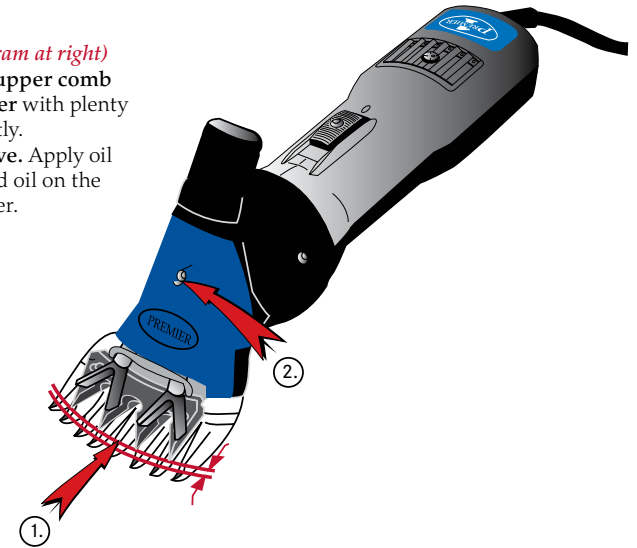

- **Purpose?** To reduce wear, reduce heat build-up and reduce the load on the motor.
- **Where should the oil be placed?** Lubricate all points on head, combs and cutters before starting the shearing machine and also in between each shearing. 3–5 drops on the top of the combs and cutters at the front of the head (2 above). Every 10 minutes (every third blade lubrication), Add 1–2 drops into the hole labeled oil on the blue plastic cover. An oil can with long nozzle works well.
- **What type of oil should be used?** We supply #10 White Clipping Oil because it is thick enough to lubricate, thin enough not to collect dirt and hair fibers and clear—thus reducing the risk of oil stains on the animal. If you wish to use another oil, be careful not to use oil that is too thick. Any light weight motor oil will work. If you're an inexperienced shearer and taking more time to shear each sheep, lubricate more often.
- **What about spray-on blade coolants?** They accelerate evaporation from the blade surfaces and thus do cool the blades more rapidly. However, all blade coolants are also excellent solvents—that remove the oil from the blades at the same time. So, if you use a coolant, immediately re-oil after the solvent/coolant has evaporated and before you continue shearing. You also need to check the tension of the blades. If they are becoming hot, the tension is probably too tight and/or the blades need more frequent lubrication with the correct oil. If blades are hot while running, tension may be too tight or combs and cutters may be dull.

# TABLE OF CONTENTS

PAGE #

<b>Premier 4000c Clipper</b> .....	<b>1</b>
Interchangeable Clipping Head .....	1
Choosing the Right Clipping Blade for Each Situation .....	2
Preparing the Animal for Clipping.....	3
Clipping Machine Lubrication .....	3
Important Warnings.....	4
Clipper Head Parts .....	5
<b>Premier 4000s Shear</b> .....	<b>6</b>
Interchangeable Shear Head.....	6
Fitting Combs & Cutters to Shear Head.....	7
Choosing the Right Combs & Cutters for Each Situation...	8
Shear Machine Lubrication .....	9
Important Warnings .....	10
Shear Head Parts.....	11
<b>Shearing Instructions/Diagrams</b> .....	<b>12–15</b>
<b>Power Supply, Safety Issues</b> .....	<b>16</b>
<b>Storing Blades &amp; Sharpening</b> .....	<b>16</b>
<b>Maintenance, Troubleshooting</b> .....	<b>17</b>
<b>Repair,Warranty &amp; Precaution</b> .....	<b>17</b>

## Maintenance

It is important to keep plug and cable clean, dry and in good order. The motor and drive gears will give years of trouble-free use if maintained and serviced regularly. Do the following steps at the end of each season, or more regularly if used extensively.

- **Air filter**—the filter should be removed and meticulously cleaned with a soft brush and soapy water (make sure the filter is dry before placing it back on the machine) after each animal is clipped to ensure efficient running of the motor. *If this maintenance is ignored, overheating of motor will occur. Possible irreversible damage or inefficient clipping will result. Warning: Do not run the clipper or shear with the filter removed! All maintenance should be carried out with the unit switched off and removed from 110 v power supply.*
- **Grease**—the internal gear system was pre-greased at the factory. Regreasing is rarely necessary. (Premier’s service technicians tell us that people often put too much grease in the gears of other clippers or shearers.)

## Troubleshooting

### Failure to cut

- Blades may be dull—resharpen.
- Dirt or fiber between the blades—remove blades; wipe cutting surfaces clean; refit blades and oil.

### Low power

- Voltage may be low—use shorter or larger (in wire gauge) extension cord. Move animals closer to the power point.
- Motor may be worn or clogged with dirt and hair—send to qualified technician to examine and replace if necessary.

### Overheating of motor

- Air filter may be plugged with fiber or dirt—remove, wash, dry and replace.
- Blades tension may be too tight—reset tension knob to 2.5 turns less than fully tight.
- Blades have not been oiled often enough—lubricate as instructed.

### Motor won’t start

- Tension bolt/spring may have been wound too tight—check and adjust to 2.5 turns back from fully tight.
- Motor’s 110 volt AC power cord may be damaged internally (e.g. from animals stepping on it)—examine cord carefully. Replace if damaged.

## Repair

Send the clipper/shearer to a qualified technician. Premier is the ultimate repair shop for repairing all clippers/shearers that we sell. Our dealers are also developing the skills and inventorying parts. Call us for details.

## Warranty

Defective parts and workmanship are repaired free of charge for up to 3 years on the 4000 clipper and shearer from the original date of purchase. Does not apply to obvious abuse (e.g. damage from dropping, exposure to chemicals, immersion in water), lack of maintenance and/or broken, dull or rusted blades.

**WARNING:** Risk of electrical shock. Connect only to a branch circuit protected by a ground-fault circuit-interrupter (GFCI). Contact a qualified electrician if you cannot verify that the circuit is protected by a GFCI.